

Installation Instructions

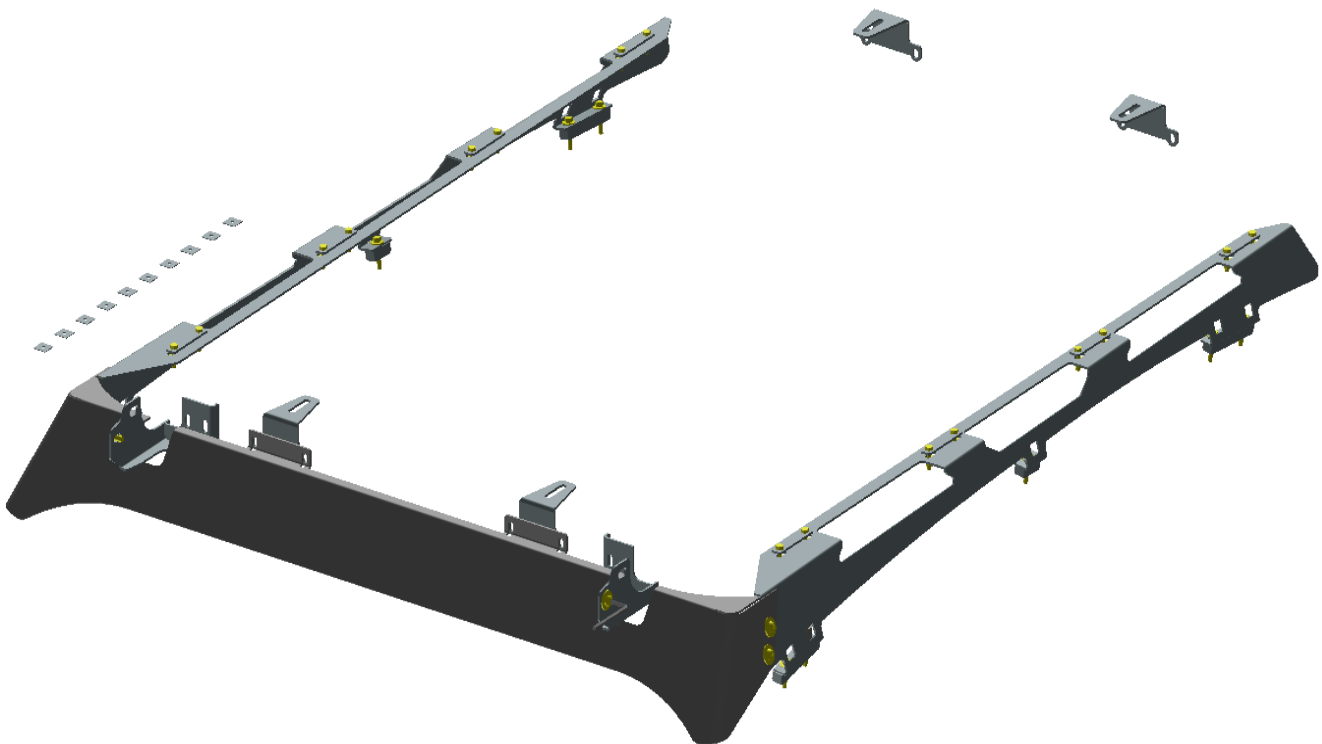

05-22 Toyota Tacoma Defender Platform Mounting Kit Part # S/BT01



For Technical Support / Warranty Information please call **800-776-0767 EXT 1317**
Smittybilt, 400 W Artesia, Compton, CA 90220

Introduction

Thank you for choosing Smittybilt accessories for your **Toyota Tacoma**. If you would like to view our full range of available accessories, please visit us at www.smittybilt.com



Important Notes Before Starting

! IMPORTANT NOTE

Carefully read through this entire instruction manual thoroughly before attempting to install this part. Please refer to the vehicle's owner's manual for roof weight capacity (include weight of rack). Check that all fasteners are properly torqued after installing the roof rack and driving a short distance. Fasteners should be checked regularly before loading roof rack. Fasten loads securely and evenly distribute loads across the rack. Lower the center of gravity of all loads as much as possible. Wind can affect driving sensitivity with roof racks.

! WARNING

Serious injury can occur when working on vehicles alone.

When possible, work with another person to reduce risk of injury from strain or other dangers that can occur when working alone.

The following tools will be required to complete the installation of this part:

TOOLS REQUIRED

13mm Socket	13mm Wrench	10mm Socket
3/8 Drive Ratchet	Pry Tool	Measuring Tape



For Technical Support / Warranty Information please call 800-776-0767 EXT 1317
Smittybilt, 400 W Artesia, Compton, CA 90220











Box Contents & Technical Information

Box Contents



IMPORTANT NOTE

Some applications require modification:

Description	Quantity	Screenshot
Wind deflector	1	
Driver bracket	1	
Passenger bracket	1	
LED light mount Driver	1	
LED light mount Pass	1	
Square light mount	4	
M6*25 Bolt plate	8	
Spacer Small	2	
Spacer Large	4	
Rubber Plate Large	4	
Rubber Plate Small	2	
Protective Rubber Strip	1	



For Technical Support / Warranty Information please call 800-776-0767 EXT 1317
Smittybilt, 400 W Artesia, Compton, CA 90220

Installation Instructions: Mechanical Installation



Step 1:

First remove the weather stripping, to remove pry the back part of the stripping up first then lift the longer strip up and take off. Once stripping is off remove the factory tape (front & rear) to reveal the nut inserts.



Step 2:

Remove the backing on the provided padding strips and stick it to the back of the roof mount spacers.



For Technical Support / Warranty Information please call 800-776-0767 EXT 1317
Smittybilt, 400 W Artesia, Compton, CA 90220

Installation Instructions: Mechanical Installation



Step 3:

Place the spacers over the nut inserts with the padding facing down. Mount the brackets on top of the spacers and install the provided M6 bolts and washers and tighten with a 10mm wrench. (Repeat on left side)

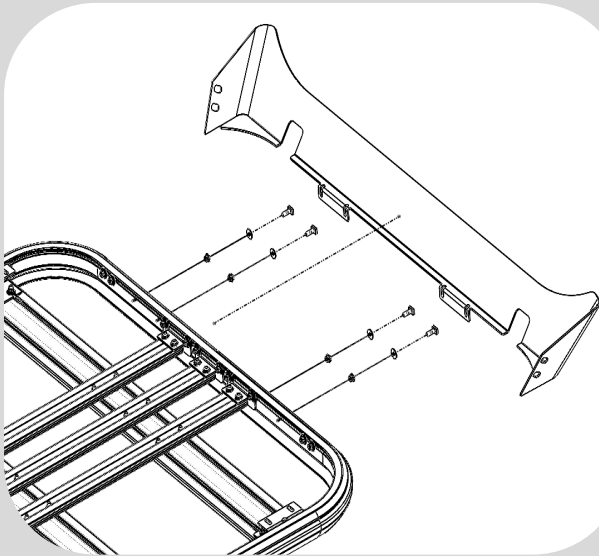

Step 4:

Install wind deflector onto the front of the roof rack using the pre installed T bolts (located inside where arrows point upwards). Using the M6 nylock nuts and washers tighten the wind deflector. Apply weather strip to the front of the deflector.

Note: Once wind deflector is tightened move the (2) outer stringers inward until they make contact with deflector then tighten all the nuts. (Make sure stringers are parallel)



For Technical Support / Warranty Information please call 800-776-0767 EXT 1317
Smittybilt, 400 W Artesia, Compton, CA 90220

Installation Instructions: Mechanical Installation



Step 5:

(2) People required for this step. Mount the roof rack on top of the truck and line up the mounting holes.

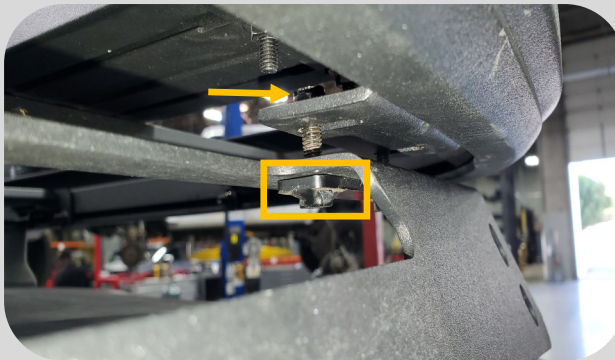

Insert the M6 bolt plate from the bottom to the top. Insert the M6 washers and nylock nuts and tighten using a 10mm wrench.



Step 2:

Finally install the (4) M8 bolts, washers and nylock nuts and tighten with a 13mm wrench and socket (do the same for the driver side). You are now complete with the installation.... Good job.



For Technical Support / Warranty Information please call 800-776-0767 EXT 1317
Smittybilt, 400 W Artesia, Compton, CA 90220

Bolt Torque Specifications

Use this only as a guide for hardware without a called out torque specification in the instruction manual.

Bolt Torque and ID						
Decimal System			Metric System			
<i>All Torques in Ft. Lbs. Maximums</i>						
Bolt Size	Grade 5	Grade 8	Bolt Size	Class 9.8	Class 10.9	Class 12.9
5/16	15	20	M6	5	9	12
3/8	30	45	M8	18	23	27
7/16	45	60	M10	32	45	50
1/2	65	90	M12	55	75	90
9/16	95	130	M14	85	120	145
5/8	135	175	M16	130	165	210
3/4	185	280	M18	170	240	290

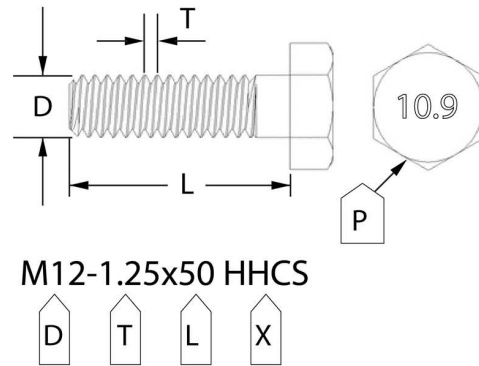
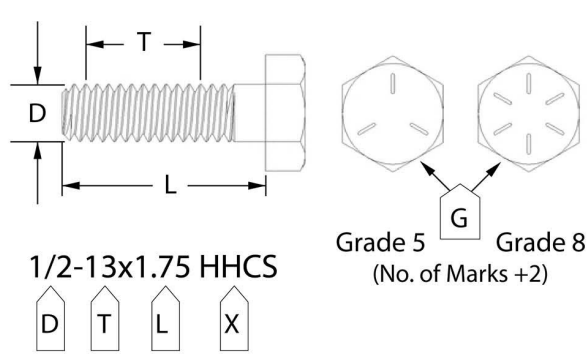

G= Grade (Bolt Strength)
 D= Nominal Diameter (Inches)
 T= Thread Count (Threads per Inch)
 L= Length (Inches)
 X= Description (Hex Head Cap Screw)

P= Property Class (Bolt Strength)
 D= Nominal Diameter (Millimeters)
 T= Thread Pitch (Thread Width, mm)
 L= Length (Millimeters)
 X= Description (Hex Head Cap Screw)



For Technical Support / Warranty Information please call 800-776-0767 EXT 1317
 Smittybilt, 400 W Artesia, Compton, CA 90220

Notes and Disclaimers

Product cleaning and maintenance instructions

Stainless Steel Finish – Aluminum polish may be used to polish small scratches and scuffs on the finish. Mild soap, window or glass cleaner may be used to clean the finish. Dual state powder coat finish – Mild soap, window or glass cleaner may be used to clean the finish. In order to protect the finish, you may wax your product on a regular basis with pure carnauba automotive wax. Do not use any types of soap, polish or wax that contains abrasive that could damage the finish. Textured coated finishes should be cleaned with a mild soap on a damp sponge. Do not apply polish or wax that requires to be removed by means of buffing. This type of wax is commonly used at car wash facilities. Chrome Finish – Mild soap, window or glass cleaner may be used to clean the finish. In order to protect the finish, you should wax your product on a regular basis with pure carnauba automotive wax. Do not use any types of soap, polish or wax that contains abrasive that could damage the finish.

Limited Warranties

Smittybilt's products are covered under the following limited warranties only. Note that the duration of the limited warranty differs according to the material and finish of the product purchased. Subject to the duration and conditions of the limited warranty stated below, Smittybilt warrants to the original retail purchaser that its products are free from defects in material and workmanship. All other warranties and representations express or implied, are hereby disclaimed, including fitness for merchantability and buyer's intended use or purpose. All parts are sold "AS IS" except for the limited warranties granted herein. Buyer assumes all risks as to the selection, suitability and performance of all goods and products selected. This limited warranty does not cover damage or impairment in any part due to misuse, improper installation, accident or contact with on-road or off-road hazards, product modification, improper or inadequate cleaning and/or maintenance. Smittybilt is not responsible for items damaged during shipping. This warranty is not transferable from the original buyer. For the original Buyer to be eligible for the limited warranty coverage, the Buyer must provide proof of purchase. Smittybilt strongly recommends returning the warranty registration card. Customer's remedy hereunder shall be limited only to repair or replacement (at Smittybilt's option) of any defective part(s) returned to Smittybilt at customer's expense. The determination of whether or not a returned part is defective or subject to coverage under the limited warranties stated herein shall be made at Smittybilt's sole discretion. To assure product quality, Smittybilt reserves the right to change product design, material, specification and finishes without prior notice to customers. This limited warranty gives you specific legal rights and you may also have other rights, which may vary from state to state. Some states do not allow limitations on how long an implied warranty lasts, so the above limitations may not apply as to you. Also, some states do not allow the exclusion or limitation of incidental or consequential damages, so the above limitations or exclusions may not apply to you. Smittybilt reserves the right to discontinue product lines and substitute products or provide other remedies than those listed in this limited warranty for those discontinued products.

Warning

Rollover and other types of vehicle accidents may result in serious injury or death to you, your passengers and others sharing the road. Smittybilt accessories are decorative and are not intended to reduce or avoid injury or damage in the event of an accident. The weight and location of Smittybilt accessories may affect your vehicles' handling, stability and performance, creating an increased risk of accident or rollover. Before installing any accessory, check state laws and assure that the accessory will not obscure any lights or interfere with proper operation on your vehicle's safety equipment. Consult your owner's manual and the Smittybilt instructions, or additional safety information. Smittybilt products, nor the warnings contained herein, are not a substitute for your safe driving. Don't drink and drive, always use seat belts and don't drive faster than conditions permit.



WARNING: Cancer and Reproductive Harm
www.P65Warnings.ca.gov



For Technical Support / Warranty Information please call 800-776-0767 EXT 1317
Smittybilt, 400 W Artesia, Compton, CA 90220