

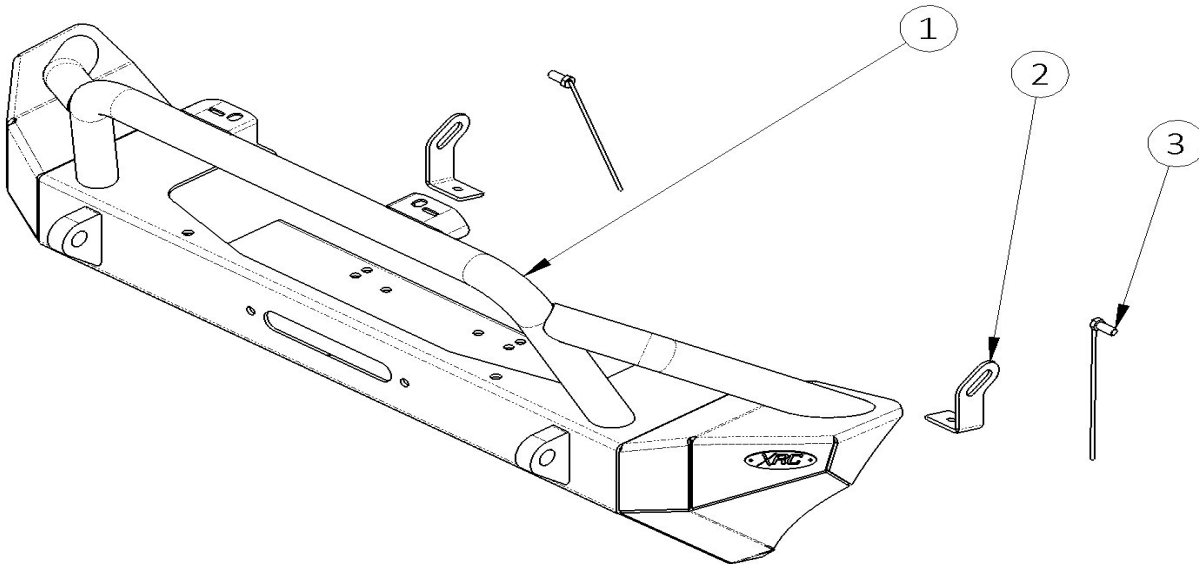

# Installation Instructions

*XRC Bumper (Part # SB77806)*  
*2007 - Pres Jeep JL & JK Front Bumper*

**NOTE: Carefully read entire instructions thoroughly before attempting to install this part.**



PART NUMBER	DESCRIPTION	QTY	ID
401WBO01	BUMPER	1	1
401WB002	FRAME BRACKET	2	2
401WB003	STUD ON A STICK	2	3
77806-01	HARDWARE PACK	1	
	10MM FL WASHER DIN 125 BLACK ZINC	4	
	10MM NYLOCK NUT GR 10.9 BLACK ZINC	4	
77806-02	HARDWARE PACK	1	
	M8 X 30MM BHCS GR 10.9 BLACK ZINC	2	
	M8 FL WASHER DIN 125 BLACK ZINC	2	
	M8 LOCK WASHER DIN 125 BLACK ZINC	2	
	M8 NUT GR 10.9 BLACK ZINC	2	
77806-03	HARDWARE PACK	1	
	M8 FL WASHER DIN 125 BLACK ZINC	2	
	M8 LOCK WASHER DIN 125 BLACK ZINC	2	
	M8 NUT GR 10.9 BLACK ZINC	2	

**For Technical Support/Warranty Information please call 310-762-9944**

**Smittybilt, 400 W Artesia, Compton, CA 90220**



# Installation Instructions

*XRC Bumper (Part # SB77806)*  
*2007 - Pres Jeep JL & JK Front Bumper*

**Step 1** : Park the vehicle on a flat level surface. Apply the parking brake and chock all (4) wheels.

**NOTE** : *Installation performed on Jeep Sahara and Jeep Rubicon will be similar.*

**Step 2** : Remove the (2) OE bolts and (8) OE plastic push rivets securing the plastic skid plate to the OE metal skid plate. (Fig. A-1 & A-2)

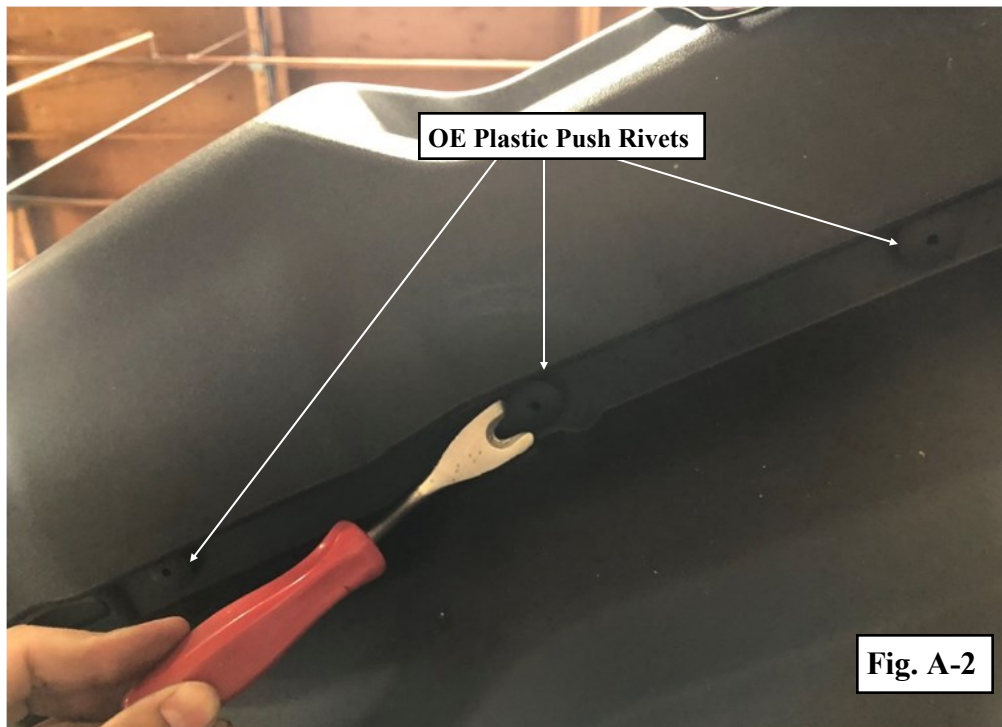
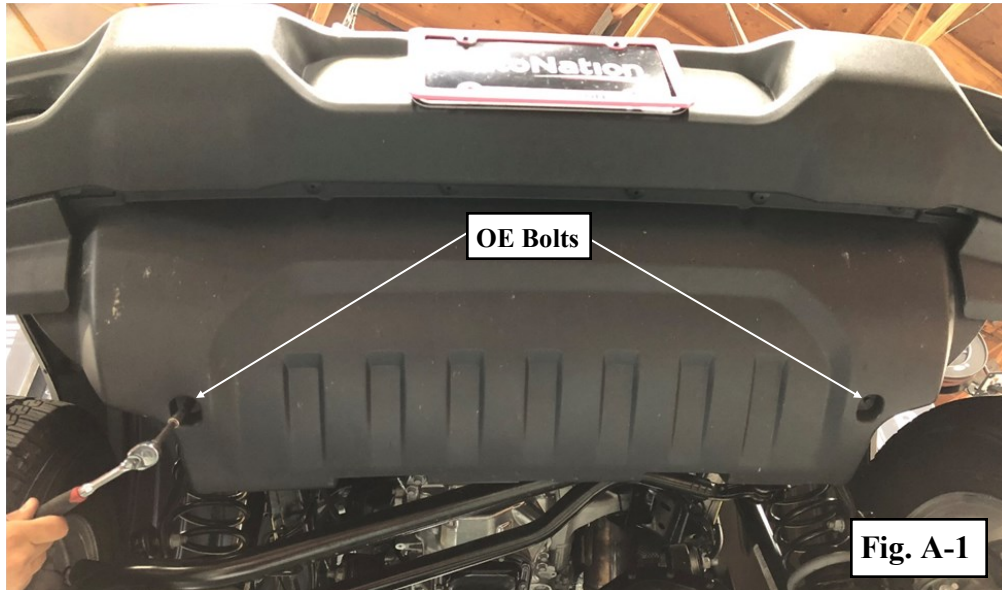

For Technical Support/Warranty Information please call 310-762-9944



# Installation Instructions

## *XRC Bumper (Part # SB77806)*

### *2007 - Pres Jeep JL & JK Front Bumper*

**Step 3** : Depress locking tab and disconnect the OE fog light wire harness connector located on the passenger side of the vehicle. (Fig. B)

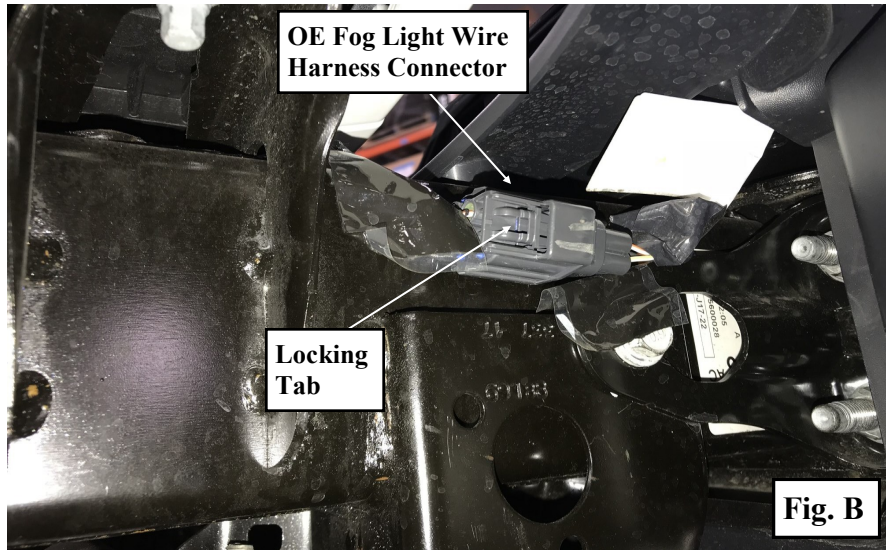

**Step 4** : Remove the (4 Per Side) OE nuts securing the OE front bumper to the frame. (Fig. C)

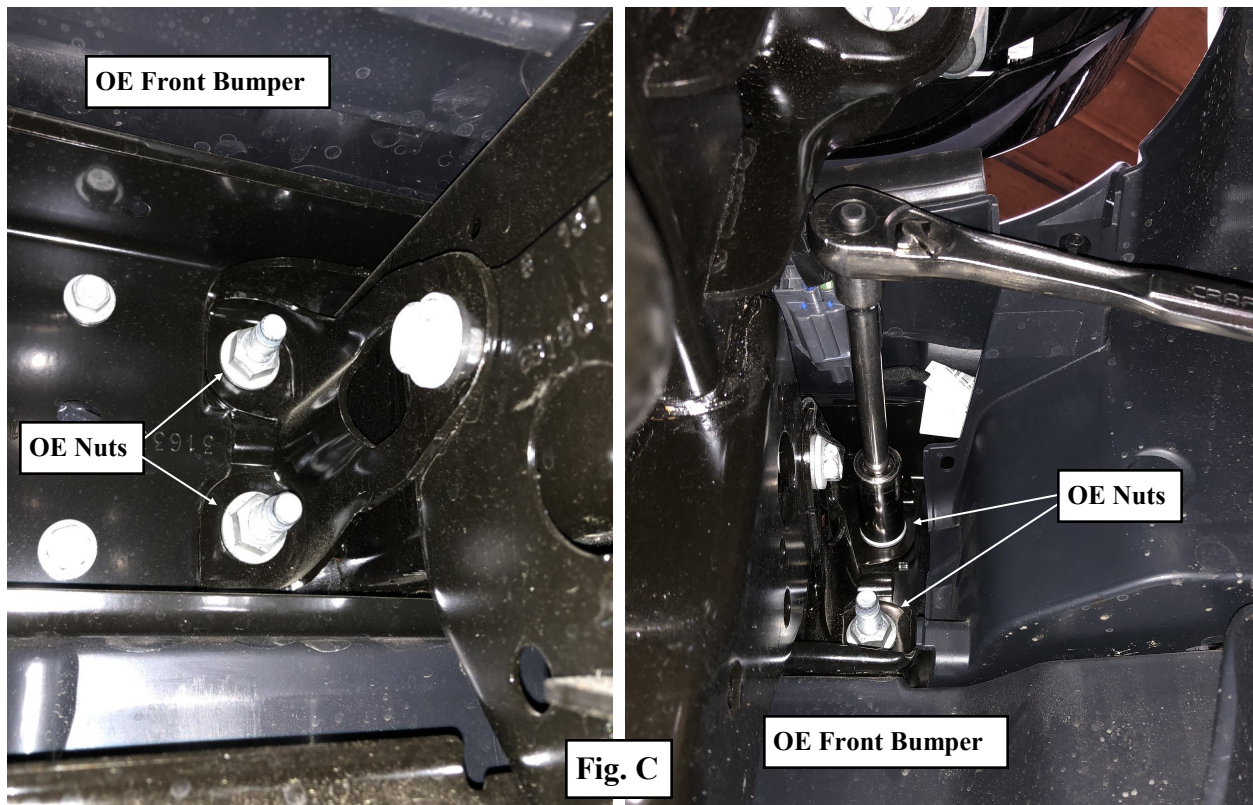

For Technical Support/Warranty Information please call 310-762-9944



# Installation Instructions

*XRC Bumper (Part # SB77806)*  
*2007 - Pres Jeep JL & JK Front Bumper*

**Step 5** : Remove the upper bumper plastic trim by removing (2) OE push pins. (Fig. D)

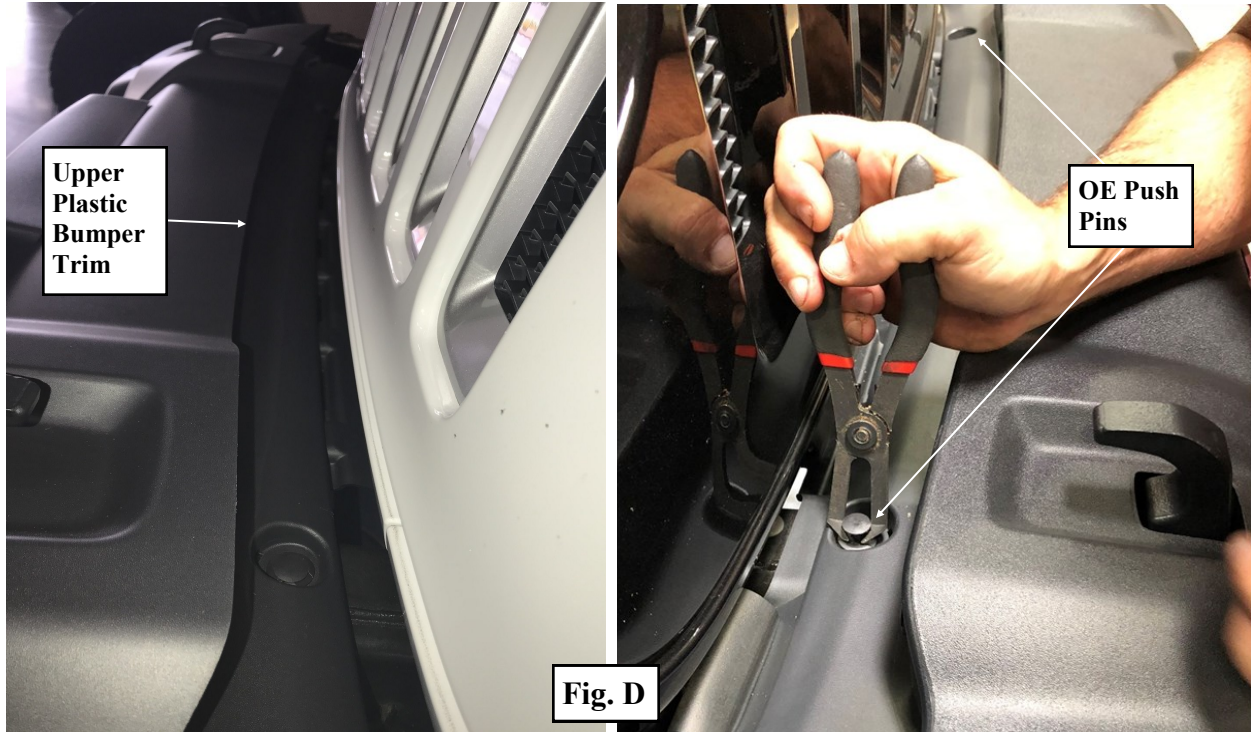

**Step 6** : Carefully remove the OE front bumper from the vehicle.

**Step 7** : Remove the (2) OE bolts securing the OE metal skid plate and remove the metal skid plate from the frame rails. Save OE hardware for reinstallation. (Fig. E)

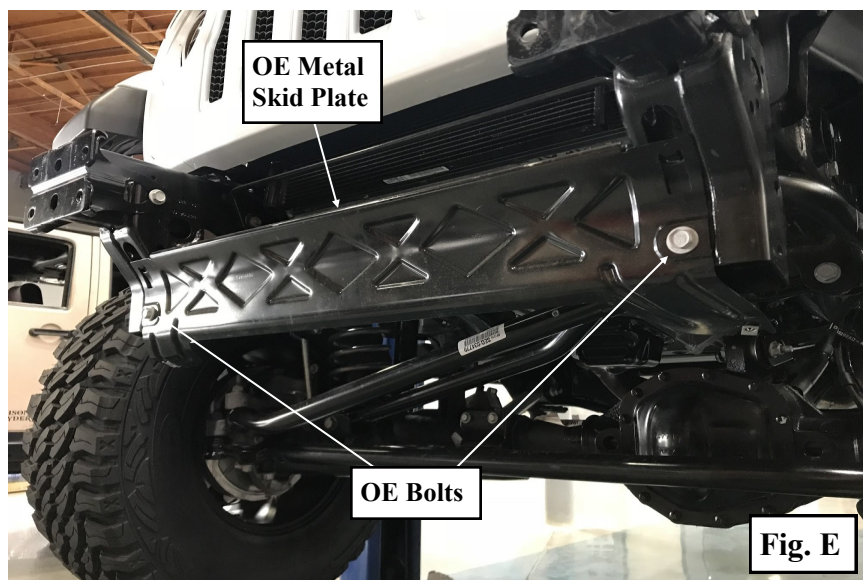

For Technical Support/Warranty Information please call 310-762-9944



# Installation Instructions

*XRC Bumper (Part # SB77806)*  
*2007 - Pres Jeep JL & JK Front Bumper*

**Step 8** : *NOTE: This step might require 2 people.* Raise the new front bumper (84-401JBXXXX) up into place and align the (4 Per Side) mounting studs on the front bumper with the holes in the frame mounting plates. Secure using the supplied (4 Per Side) 12mm nuts and washers. (Fig. F)

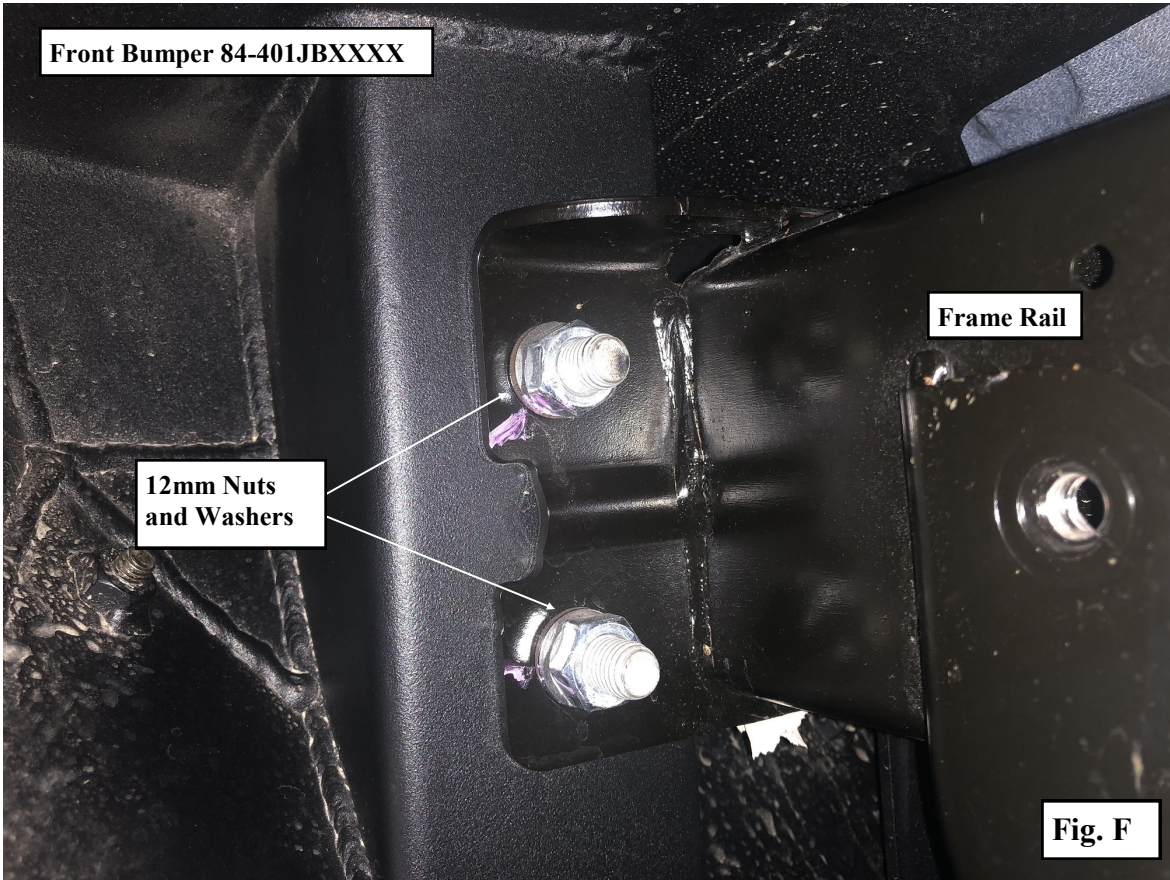

For Technical Support/Warranty Information please call 310-762-9944

Smittybilt, 400 W Artesia, Compton, CA 90220



# Installation Instructions

## *XRC Bumper (Part # SB77806)*

### *2007 - Pres Jeep JL & JK Front Bumper*

**Step 9** : Install the lower mounting tabs (**84-401JB008** drvvr and **84-401JB009** pass) to the **OE** mounting holes on frame horns using the **Supplied Nut-Plates** and **10mm OE bolts**. (**Fig. G**)

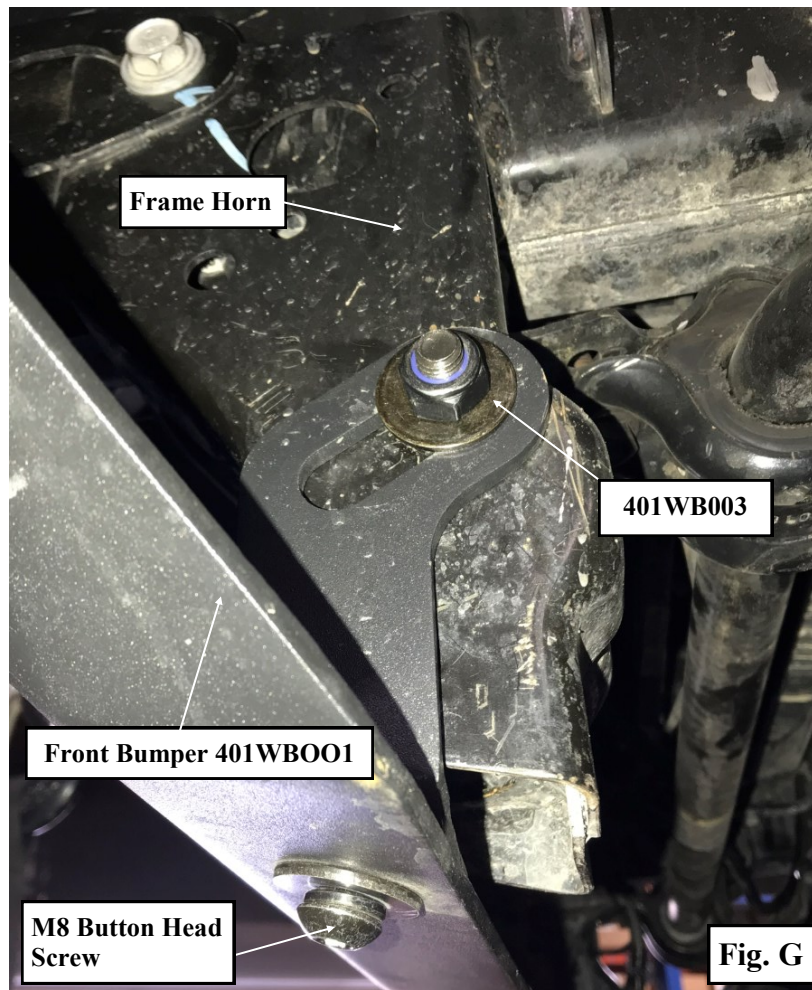

**Step 10** : Secure the (**2 Per Side**) front bumper lower mounting holes to the lower mounting tabs (**84-401JB008** drvvr and **84-401JB009** pass) using the supplied **8mm X 30mm** bolts, washers, (**Fig G**)

**Step 11** : Level the front bumper (**84-401JB XXXX**) and torque the **12mm** hardware to **70 ft./lbs**, **10 mm** to 45 ft/lbs, **8 mm** to 23 ft/lbs.

For Technical Support/Warranty Information please call 310-762-9944



# Installation Instructions

*XRC Bumper (Part # SB77806)*  
*2007 - Pres Jeep JL & JK Front Bumper*

**Step 12** : Installation is now complete.



For Technical Support/Warranty Information please call 310-762-9944

---

Smittybilt, 400 W Artesia, Compton, CA 90220



# Installation Instructions

## XRC Bumper (Part # SB77806)

### 2007 - Pres Jeep JL & JK Front Bumper

Use this only as a guide for hardware without a called out torque specification in the instruction manual.

<b>Bolt Torque and ID</b>						
<b>Decimal System</b>			<b>Metric System</b>			
All Torques in Ft. Lbs. Maximums						
Bolt Size	Grade 5	Grade 8	Bolt Size	Class 9.8	Class 10.9	Class 12.9
5/16	15	20	M6	5	9	12
3/8	30	45	M8	18	23	27
7/16	45	60	M10	32	45	50
1/2	65	90	M12	55	75	90
9/16	95	130	M14	85	120	145
5/8	135	175	M16	130	165	210
3/4	185	280	M18	170	240	290

<p>1/2-13x1.75 HHCS</p> <p><span style="border: 1px solid black; padding: 2px;">D</span> <span style="border: 1px solid black; padding: 2px;">T</span> <span style="border: 1px solid black; padding: 2px;">L</span> <span style="border: 1px solid black; padding: 2px;">X</span></p> <p><b>Grade 5    Grade 8</b> (No. of Marks + 2)</p>	<p>M12-1.25x50 HHCS</p> <p><span style="border: 1px solid black; padding: 2px;">D</span> <span style="border: 1px solid black; padding: 2px;">T</span> <span style="border: 1px solid black; padding: 2px;">L</span> <span style="border: 1px solid black; padding: 2px;">X</span></p> <p><b>P = Property Class (Bolt Strength)</b> D = Nominal Diameter (Millimeters) T = Thread Pitch (Thread Width, mm) L = Length (Millimeters) X = Description (Hex Head Cap Screw)</p>
<p>G = Grade (Bolt Strength) D = Nominal Diameter (Inches) T = Thread Count (Threads per Inch) L = Length (Inches) X = Description (Hex Head Cap Screw)</p>	

For Technical Support/Warranty Information please call 310-762-9944

Smittybilt, 400 W Artesia, Compton, CA 90220





# Installation Instructions

## *XRC Bumper (Part # SB77806)*

### *2007 - Pres Jeep JL & JK Front Bumper*

#### **Product cleaning and maintenance instructions**

Stainless Steel Finish – Aluminum polish may be used to polish small scratches and scuffs on the finish. Mild soap, window or glass cleaner may be used to clean the finish. Dual state powder coat finish – Mild soap, window or glass cleaner may be used to clean the finish. In order to protect the finish, you may wax your product on a regular basis with pure carnauba automotive wax. Do not use any types of soap, polish or was that contains abrasive that could damage the finish. Textured coated finishes should be cleaned with a mild soap on a damp sponge. Do not apply polish or was that requires to be removed by means of buffing. This type of wax is commonly used at car wash facilities. Chrome Finish – Mild soap, window or glass cleaner may be used to clean the finish. In order to protect the finish, you should wax your product on a regular basis with pure carnauba automotive wax. Do not use any types of soap, polish or was that contains abrasive that could damage the finish.

#### **Limited Warranties**

Smittybilt's products are covered under the following limited warranties only. Note that the duration of the limited warranty differs according to the material and finish of the product purchased. Subject to the duration and conditions of the limited warranty stated below, Smittybilt warrants to the original retail purchaser that its products are free from defects in material and workmanship. All other warranties and representations express or implied, are hereby disclaimed, including fitness for merchantability and buyer's intended use or purpose. All parts are sold "AS IS" except for the limited warranties granted herein. Buyer assumes all risks as to the selection, suitability and performance of all goods and products selected. This limited warranty does not cover damage or impairment in any part due to misuse, improper installation, accident or contact with on-road or off-road hazards, product modification, improper or inadequate cleaning and/or maintenance. Smittybilt is not responsible for items damaged during shipping. This warranty is not transferable from the original buyer. For the original Buyer to be eligible for the limited warranty coverage, the Buyer must provide proof of purchase. Smittybilt strongly recommends returning the warranty registration card.

Customer's remedy hereunder shall be limited only to repair or replacement (at Smittybilt's option) of any defective part(s) returned to Smittybilt at customer's expense. The determination of whether or not a returned part is defective or subject to coverage under the limited warranties stated herein shall be made at Smittybilt's sole discretion.

To assure product quality, Smittybilt reserves the right to change product design, material, specification and finishes without prior notice to customers. This limited warranty gives you specific legal rights and you may also have other rights, which may vary from state to state. Some states do not allow limitations on how long an implied warranty lasts, so the above limitations may not apply as to you. Also, some states do not allow the exclusion or limitation of incidental or consequential damages, so the above limitations or exclusions may not apply to you. Smittybilt reserves the right to discontinue product lines and substitute products or provide other remedies than those listed in this limited warranty for those discontinued products.

#### **Warning**

Rollover and other types of vehicle accidents may result in serious injury or death to you, your passengers and others sharing the road. Smittybilt accessories are decorative and are not intended to reduce or avoid injury or damage in the event of an accident. The weight and location of Smittybilt accessories may affect your vehicles' handling, stability and performance, creating an increased risk of accident or rollover. Before installing any accessory, check state laws and assure that the accessory will not obscure any lights or interfere with proper operation on your vehicle's safety equipment. Consult your owner's manual and the Smittybilt instructions, or additional safety information. Smittybilt products, nor the warnings contained herein, are not a substitute for your safe driving. Don't drink and drive, always use seat belts and don't drive faster than conditions permit.

**For Technical Support/Warranty Information please call 310-762-9944**

**Smittybilt, 400 W Artesia, Compton, CA 90220**